



**AMERICAN CRANE  
& EQUIPMENT CORPORATION**  
DOUGLASSVILLE, PA. 19518 U.S.A.  
PHONE: 610-385-6061  
FAX: 610-385-3191

**TOP RUNNING TROLLEY  
W/ OPEN DECK HOIST**

**25 TON CAPACITY**

**PRODUCT INFORMATION**

DWG. NO:

**A-20418-8026**

DATE: 07/20/09

REVISION: 1

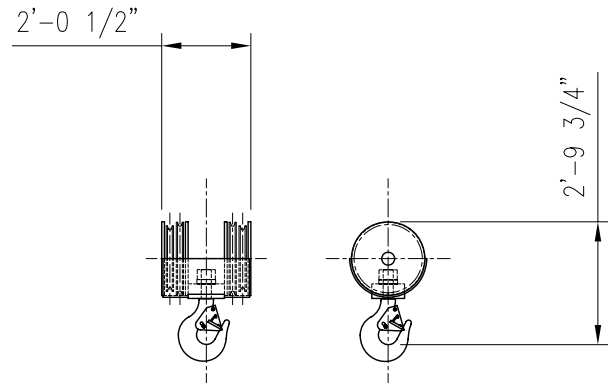
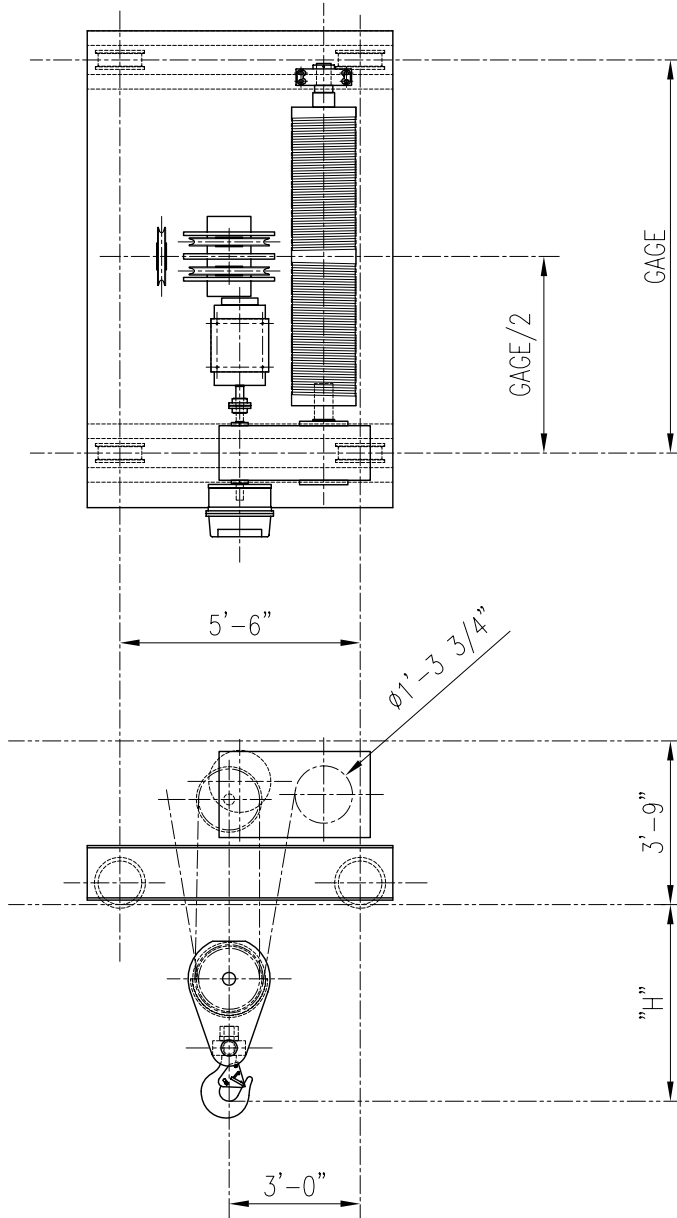

LOW HEADROOM BLOCK

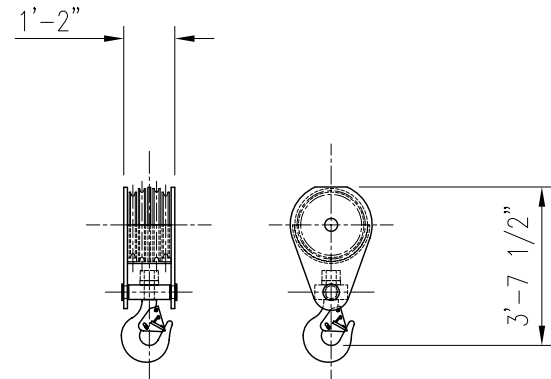

STANDARD HEADROOM BLOCK

ACECO RESERVES THE RIGHT TO MAKE CHANGES WITHOUT NOTICE.

**HOIST TECHNICAL DATA**

CAPACITY	25 TONS ( 50,000 LBS. )	HOIST SPEED	MOTOR DATA
		26 F.P.M.	50 HP / 1800 RPM
		20 F.P.M.	40 HP / 1800 RPM
CLASS	CMAA CLASS "E"	16 F.P.M.	30 HP / 1800 RPM
POWER SUPPLY	460V-3PH-60HZ		

**DIMENSIONAL INFORMATION**

MODEL NUMBER	GAGE	HEIGHT OF LIFT ON HOIST		H	
		STANDARD HEADROOM LOWER BLOCK	LOW HEADROOM LOWER BLOCK	STANDARD HEADROOM LOWER BLOCK	LOW HEADROOM LOWER BLOCK
20418-8026-9	9'-0"	48'-3"	40'-3"	4'-6"	3'-8"
20418-8026-10	10'-0"	57'-6"	49'-6"		
20418-8026-11	11'-0"	66'-9"	58'-9"		